



SOUTHERN WOODS

TREE NURSERY SPECIALIST



Main South Road, Templeton,
Ph 0800 800 352
robyne@southernwoods.co.nz

Christchurch 8441
Fax 347 9223
www.southernwoods.co.nz

PRUNING FLOWERING CHERRIES & PLUMS

In General...

Pruning and shaping will be the heaviest the first year. A little may be required the second year –mostly tip-pruning so that in later years, there may be little or no pruning at all. Pruning is done during the winter months, when the tree is dormant.

Nearly all the flowering cherries sold by Southern Woods are ‘high worked’ on colt variety rootstock. This is a very disease-resistant rootstock, producing an abundance of fine, fibrous roots. If a tree is ‘high-worked’, it will be grafted at the top of the stem. Any shoots that later occasionally arise from this stem should always be removed. If the shoot reappears, it may need to be cut out as shown below.

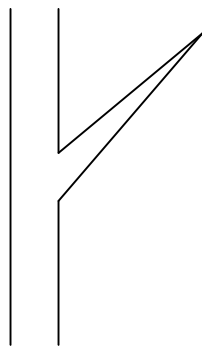

Old Shoot

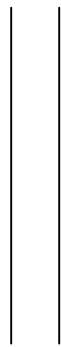

Trimmed



Regrowth



Cut on Angle

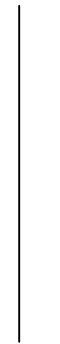

*Eye of shoot
Removed*

Tree after Planting but Before Shaping

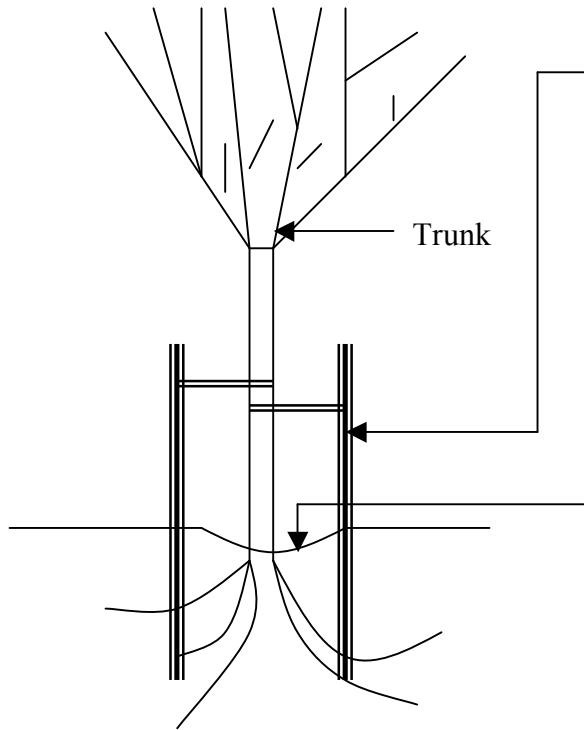

Tree is double-staked. It has been tied with webbing as two separate ties – one tie with loop around the tree trunk from each stake. This will keep the lower stem firm and allow the root system to develop in peace. Don't place ties above 1m. This will allow the top of the tree to move so strengthening the trunk. Monitor the ties regularly to check whether they are firm, and not damaging the stem.

On well-drained ground plant in a slight depression to allow water to soak down into the root ball. On poorly drained ground raise the tree up on a small mound.

Tree After Shaping

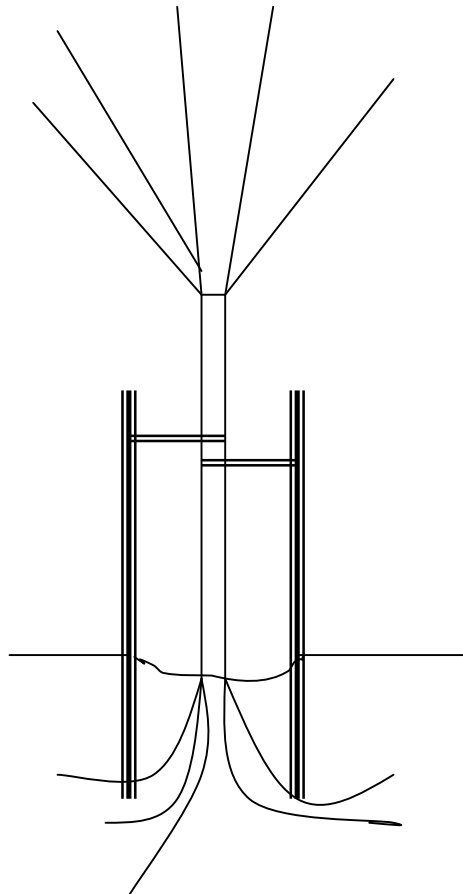

Prune out any branches that are crossing over or are very close to another branch.

Tip-prune (cut back) all main branches – this may be up to 50cm removed. Also tip-prune any side twig growth by 5cm.

Always prune to an outward-facing bud (except for *P. Shirotae* and *P. Shimidsu Sakura* varieties – see following page for specific instructions on pruning these varieties.)

Pruning and tipping will encourage the production of side shoots and thicker, stronger stems. If a tree is planted and not pruned, many of the lower buds and shoots will simply wither or die off. Reducing some of the growth also assists in the tree coping better from any transplanting shock.

Shirotae & Shimidsu Sakura

Both of these are spreading forms of flowering cherries. When pruning these varieties, always prune to an inside bud. After approximately two years the upward-facing branches will naturally begin to arch downward to form the spread. For this reason, prune to an inside bud so the new shoots arch out on the upper side of the branches once they have moved downwards.

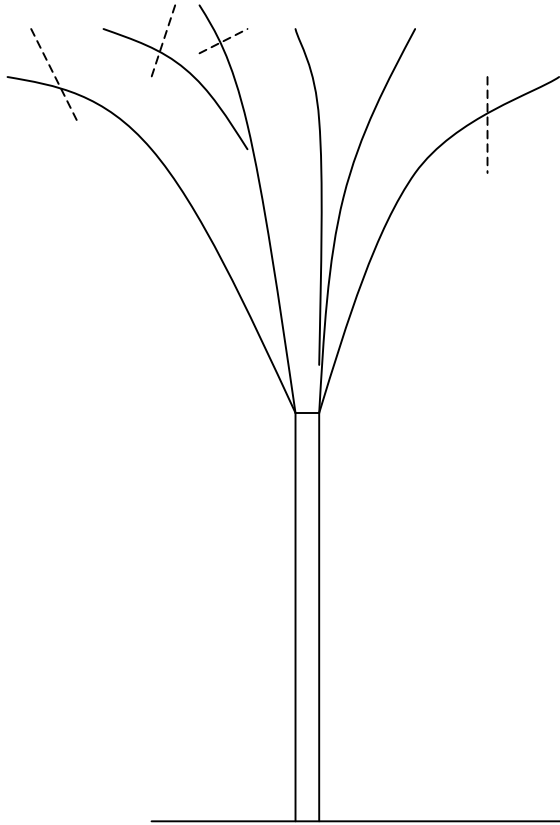

Tip-prune to an inside bud

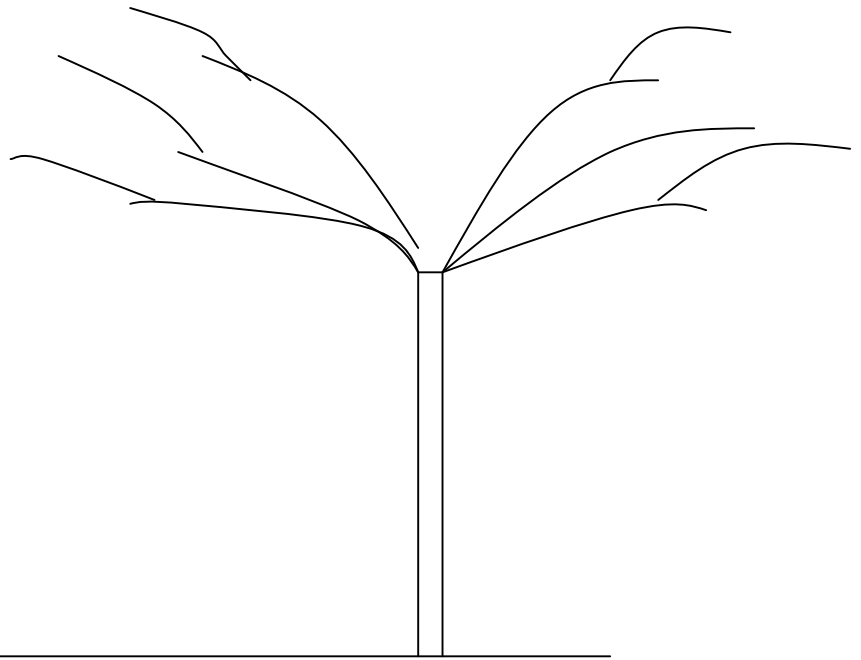

After two years.... New growth arising from tip-pruned branches

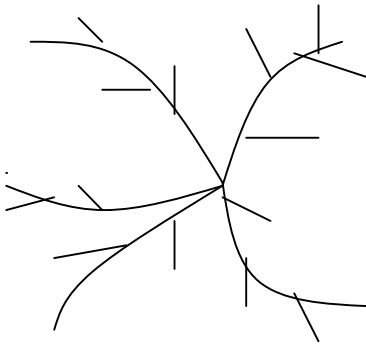

Bird's Eye View – pruned tree has branches with new twiggy growth filling in.

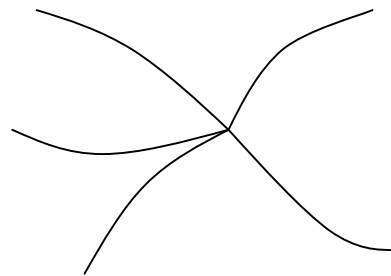

Bird's Eye View - Unpruned – little twig growth.

Pruning of Weeping Forms of Trees (Includes Cherries, Maples, Silver Pear & Crab Apple)

If left un-pruned, the weeping branches will very quickly reach the ground and there will be only minimal additional twig growth and infill of branches.

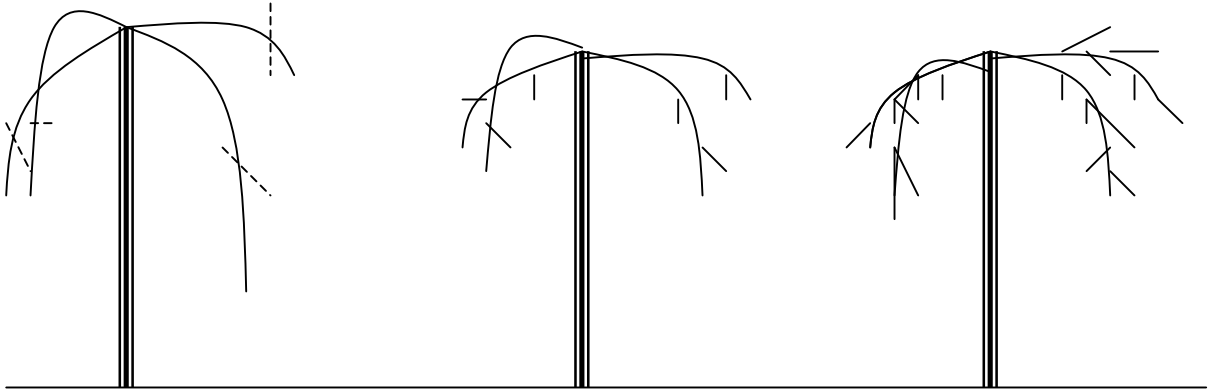

Tree After Planting –
reading for shaping.

Cut out any crossing over
branches. Tip-prune
(shorten) all main branches
to an outward facing bud.

Twig growth after two
years showing the new
branches and twig growth
forming.

NB

With maples, prune only very lightly, as it is usual for a maple to die back at least one or two nodes after pruning. Also (even in mid winter) a maple will drip some sap for several weeks. There is no need to have any concern over this. The weeping of sap will stop of its own accord in time.